

The Acoustics of the Piano

Juan José Burred

Professional Conservatory of Music *Arturo Soria*, Madrid

Revised version, September 2004

Translated by David Ripplinger, April 2009

Contents

1	Introduction	1
2	The origin and evolution of the piano	2
3	The action	5
3.1	The influence of articulation and touch in sound quality	6
4	Hammer and string interaction	12
4.1	The nonlinearity of the hammer	12
4.2	Contact time	13
4.3	Other factors to consider	16
5	The strings	18
5.1	Scale design	18
5.2	The string ratio	19
5.3	Inharmonicity	22
5.4	Double decay	26
5.5	Spectral consequences	30
5.6	The pedals	34
6	The soundboard	36
	Bibliography	39

Chapter 1

Introduction

The technological innovations introduced in the piano throughout its history have been, up to the 20th century, the fruits of experimentation and intuition, and not of previous scientific study. This affirmation is generally true for any acoustic musical instrument. In reality, the piano is one of the most complex musical instruments that exist, and its rigorous physical study is a difficult task that could not be undertaken successfully before the development of an advanced acoustical theory, such as the one developed by Helmholtz at the end of the 19th century. Subjects such as hammer-string interaction, complete mechanical comprehension of the percussive action, or explanation of some tonal characteristics of the piano still have not been resolved satisfactorily, and they constitute one of the most interesting investigative fields in musical acoustics. Only in recent years, with the help of advanced computers and technological equipment, are complete and real physical models of the (unsimplified) piano being formulated [1]. These will allow, through a better understanding of the instrument, the proposal of new improvements in its manufacture, as well as the contribution of ideas that could lead to new instruments.

This work presents a complete but succinct overview of the four topics in which the study of the piano is normally divided: the action, hammer-string interaction, the strings and the soundboard. Included at the beginning is a small historical introduction. At no point does there appear any complex physical or mathematical discussion; instead, a more intuitive approach is taken concerning the behavioral aspects of the piano that have a relevant influence on the sound of the instrument. For example, a detailed explanation of the extremely complex percussive action is not discussed, as it holds little interest from an acoustical perspective; however, a special emphasis is placed on the discussion of string vibrations. On the other hand, this work does not treat the details of analysis and synthesis, since here the objective is not to describe and evaluate the sound of the piano, but to explain the causes of its unique characteristics.

Chapter 2

The origin and evolution of the piano

Keyboard and string instruments, principally the clavichord, harpsichord and piano, are a somewhat recent invention. Although it is not exactly known when the first indirect action mechanism was used with strings, not until the 15th century was the first successful instrument of this type developed: the clavichord. Previously, the keyboard and chordophones had been evolving independent of each other. The first chordophones consisted of one or several strings stretched over a bar or a board. The ancient lyres and the psaltery, cited repeated times in the Bible, already had a sound box. In the sixth century B.C., Pythagoras, in his experiments to derive the mathematical proportions of the intervals, used the monochord, which consisted of a single string stretched across a wood box with a sliding bridge, which modified the speaking length of the string, and hence the frequency.

On the other hand, keyboards were the logical solution to drive the mechanism that conducted air currents through organ pipes. The architect Vitruvius (1st century B.C.) wrote about the rudimentary keys used in organs in his day. In the 2nd century A.D., Heron of Alexandria built an organ with keys furnished with springs that returned them to their initial position. During the Middle Ages, Pythagoras' monochord was joined together with a keyboard, such that every key was in fact a lever, which at one extreme had fixed on it a small bridge (called a *tangent*). The tangent, upon striking the string, divided it in the appropriate proportion and made it sound (fig. 2.1). In this instrument, polyphonic execution was obviously impossible. Later, it was made with several strings, but still not as many as there were keys, thus allowing only the playing of certain harmonic intervals. This version is named the polychord or legato clavichord, and was frequently used well into the Baroque period. Following this development came the independent clavichord, with a correspondence of one string per note, or even two unison strings per note. The final version of the clavichord was especially accepted in Galante music (mid-18th century), with

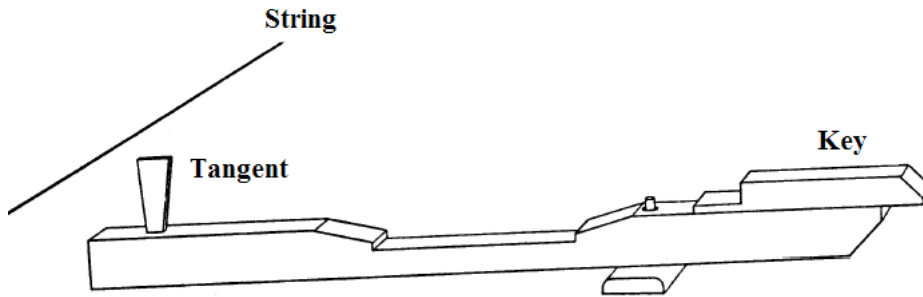

Figure 2.1: Tangent action (source: [2]).

composers such as Carl Philipp Emanuel Bach.

The principal problem with the clavichord action was that it produced a very weak sound. To its advantage, however, it offered the artist great dynamic control, even allowing the use of vibrato, since the tangent stays in contact with the string until the key is released. In search of louder volume, the spinet and virginal were developed in the 15th century, with longer strings. The method of the tangent was considered inadequate for striking larger strings, and thus people tried to imitate plucking of the strings with the finger or with a plectrum, an interaction that can produce a greater volume. This led to the development of the so-called *jack and quill* action, which consists of a small plectrum that plucks the string, and a damper that attenuates the vibration as the key is released (fig. 2.2). In the 16th century, people experimented with even longer strings and perfected the plucking method, which made way for the harpsichord. Like the

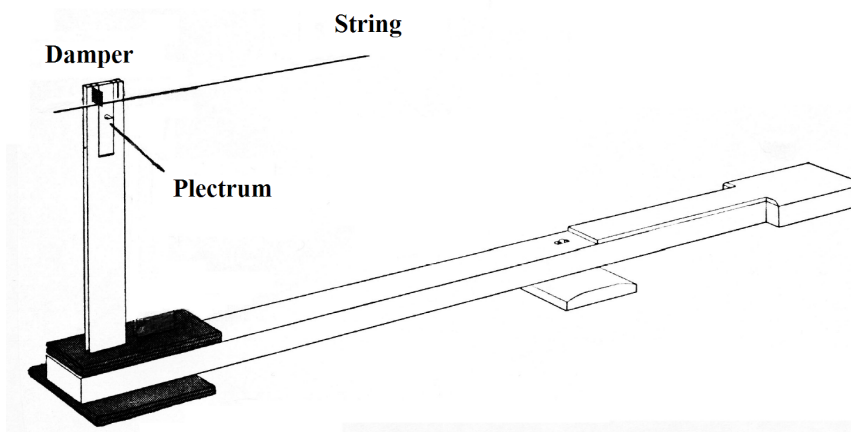

Figure 2.2: Jack and quill action (source: [2]).

clavichord, the harpsichord included several unison strings for each note in order to increase the volume.

Unfortunately, the harpsichord offers a very small dynamic range to the artist. To compensate for this, different string registers are sometimes added, driven by special plucking mechanisms, pedals or multiple keyboards. Another drawback of the harpsichord is maintenance: it needs to be tuned constantly, and the fragile plectra need to be replaced often.

The Florentine harpsichord maker Bartolomeo Cristofori tried to resolve the problems of the clavichord (low volume) and the harpsichord (scarce dynamics, poor tuning stability and little sustain) by introducing a new instrument. In 1709, he invented what he called *Gravicembalo col piano e forte*, that is, harpsichord with soft and loud sound, which would later be known as the *pianoforte*, or more briefly, the piano. In the piano, he included characteristics of its predecessors, such as the percussive nature of the clavichord, which permitted dynamics, and the winged shape and dampers of the harpsichord, but he came up with a new percussive system using small hammers. A forerunner that perhaps inspired Cristofori was the dulcimer, a trapezoidal zither that is played by striking the strings with handheld hammers. All actions that have been made since Cristofori's time have only improved on his ingenious initial design, maintaining its essential features to this day. Among these, the most important feature is the escapement: the hammer falls back immediately after striking the string, even if the key is held down. This feature significantly prolongs the duration of the notes. In 1783, the English designer Broadwood added the sustain pedal, which lifts all the dampers.

Despite its advantages, it took the piano some one hundred years to gain favor over the harpsichord. From 1800 on, improvements were made in its construction. It is worth mentioning Erard's invention of the double escapement or repetition mechanism in 1821, which allows rapid repetition of the notes, without which the virtuoso pieces of many Romantic composers would have been impossible to write. Piano cases, still made of wood, had to hold greater and greater string tension. The introduction of the iron plate in 1825 in the United States made it possible to increase the tension, and consequently the acoustic power, tremendously. In 1855, Henry Steinway, a U.S. manufacturer originally from Germany, designed a grand piano with a cast iron plate, which has served as the model for almost all instruments after that. Since then, except for small improvements, there have not been any substantial changes in piano construction.

Chapter 3

The action

Figures 3.1 and 3.2 present an extremely simplified version of the action in grand and vertical pianos, respectively. In the first, the hammer strikes the string in a vertical direction and is basically Cristofori's action. Note that the hammer is not directly connected to the key, as was the case with the tangent in the clavichord. As can be observed in the figure, the hammer receives the impulse of the key through the jack. Then, the hammer leaves the jack and continues in its course freely until it reaches the string. Consequently, the hammer is not in contact with the key at the moment it strikes the string, a crucial fact from which the interpretive characteristics of the piano are derived. The hammer, upon rebounding off the string, falls back to a midway position regulated by the backcheck, leaving the string to vibrate freely. As the key is released, the backcheck, the hammer and the damper free-fall back to the initial position. In the case of the vertical piano, the return can only be achieved using springs (see figure). This second action is considered inferior and less natural. The repetition mechanism has not been included in these schematics.

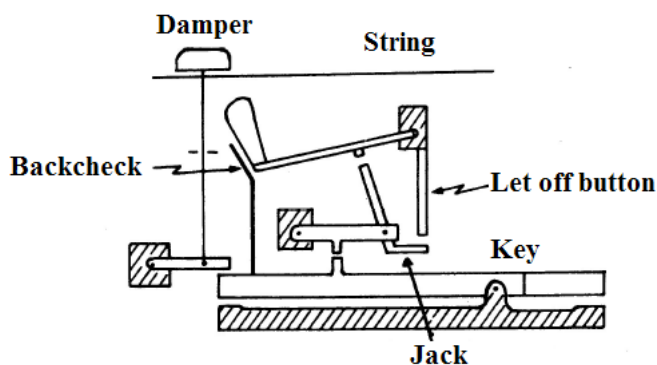

Figure 3.1: Simplified action of a grand piano (source: [3]).

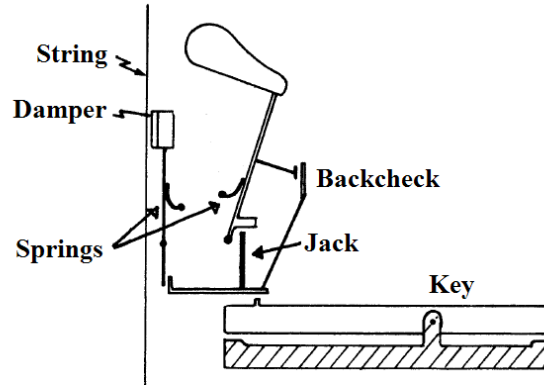

Figure 3.2: Simplified action of a vertical piano (source: [3]).

3.1 The influence of articulation and touch in sound quality

The fact that the hammer is not connected to the rest of the action at the moment of impact implies, in principle, that the sound produced can only be affected by the velocity with which the hammer strikes the string, or equivalently, by the greater or smaller force with which the key is pushed (later, it is shown that the velocity not only modifies the acoustic power, but also the tone). It is on this principle that the primary conjecture related to acoustical studies of the piano is made: Do the articulation of the fingers, the personal touch of each artist, or other interpretive factors like the position of the arm, wrist, etc., influence the resulting sound? Numerous studies have been done to answer this question. Remember that only solitary keystrokes are considered, that is, the above question is equivalent to asking if a note played by a virtuoso pianist would sound the same as the same note played with the same force on the same piano by a novice. The results of recent conclusions regarding this question are discussed below [3, 4, 5].

First, consider the schematic in figure 3.3, which is an even greater simplification of a grand action. In the figure, the key is pushed a distance of 18 cm from the fulcrum, with a force K . The height s is the distance the front of the key moves until it touches the bottom (usually about 1 cm), and the distance the hammer travels is about 5.5 times that. This implies that if V_S is the key velocity and V_0 is the velocity of the hammer, then $V_0 = 5.5V_S$.

By studying this model, several relationships can be identified between the force K , the hammer velocity V_0 and the time T_L that the key takes to move s :

$$V_0 = 5.5 \sqrt{\frac{2s(K - K_S)}{M_A}} \quad (3.1)$$

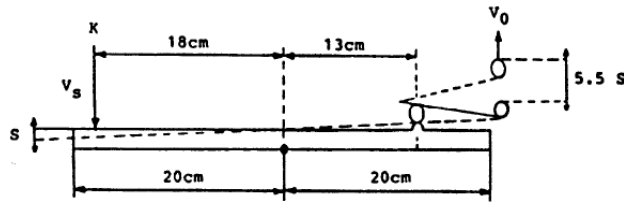

Figure 3.3: Simplified action model (source: [4]).

$$T_L = \sqrt{\frac{2M_A s}{K - K_S}} \quad (3.2)$$

where K_S is the static force necessary to move the key (or the minimum force that must be applied in order to move it) and M_A is the apparent mass that the finger feels at the point of contact. Figure 3.4 contains plots of these equations (V_0 and T_L as functions of K), with $K_S = 0.45$ N (Newtons) and $M_A = 0.3$ kg. Therefore, to move the key, K must be greater than 0.45 N, as is seen in the plot. For a force of about 0.8 N, the hammer acquires a velocity of 70 cm/s (2.52 km/h), and takes about 150 milliseconds to touch the keybed. Applying 35 N gives a velocity of 700 cm/s (25.6 km/h) and a time of 1.2 milliseconds.

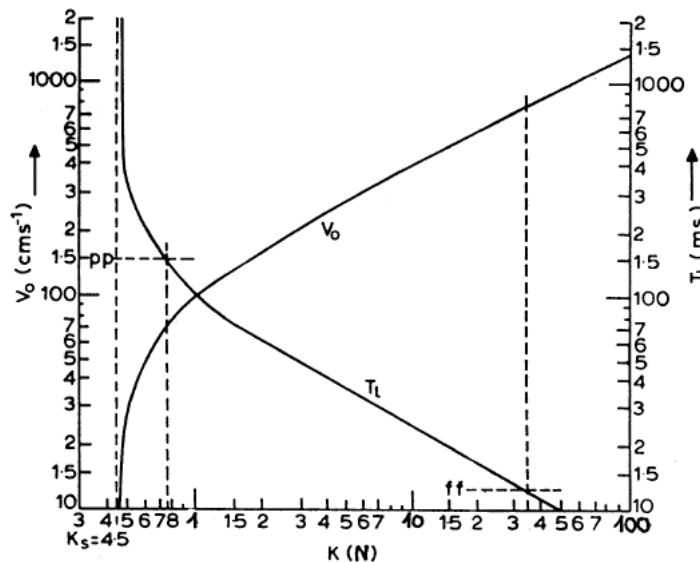

Figure 3.4: Hammer velocity and key travel time (source: [4]).

Despite the excessive simplification of the model used for these calculations,

proposed in 1965 [6], later experimental measurements confirmed that the values obtained above are a very good approximation of the real case. Later, the model was improved and made closer to the real physical system, for which the use of computer simulations that allowed the enormous amount of required calculations in the more realistic study was essential. In 1985, with the help of these models, contact times between the different parts of the key when being played were established [5]. The existence of a factor that could possibly be related to touch was discovered: the *key bottom delay*. Figure 3.5 shows the plot of contact times between the hammer and string, and between the key and keybed for different playing forces: *f* (*forte*), *mf* (*mezzoforte*), *p* (*piano*). To carry out these measurements it was assumed that the key always touches the key bottom, both in *forte* and in *piano*, which evidently is not the case in real playing. The moment at which the hammer strikes the string was taken to be the time origin.

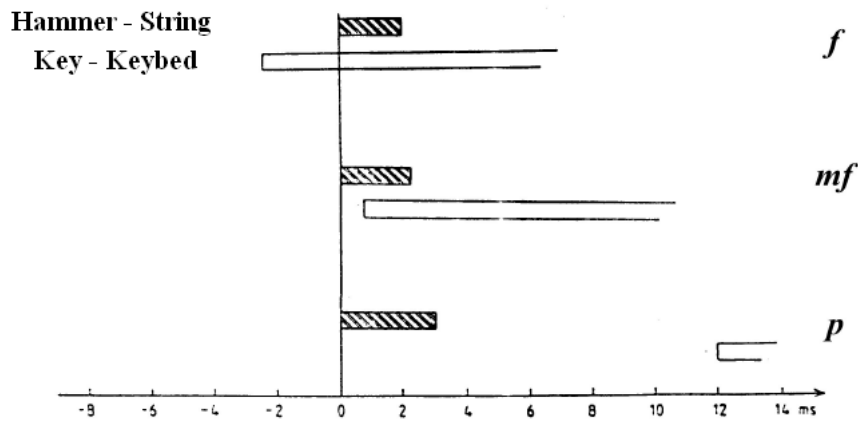

Figure 3.5: Contact times (source: [5]).

As can be observed, during a *forte* blow the key reaches the bottom about 2 milliseconds before the hammer-string contact. During a *piano* blow the string is hit first, and several milliseconds later the key contacts the bottom (in this case 12 milliseconds were measured). The key bottom delay is the time between hammer-string contact and key bottom contact, and is negative if the key bottom contacts first. The idea that this delay was somehow a consequence of how the key is played (not just the amount of force) was discarded when a comparison was made between keystrokes made by people without any musical knowledge and by professional pianists. In each case the above mentioned delay was measured, and the result is seen in figure 3.6: there is no significant difference between pianists and non-pianists.

The experimentally proven fact is that different articulations (*staccato*, *legato*, etc.) do influence the movement of the key and action, as shown in figure 3.7.

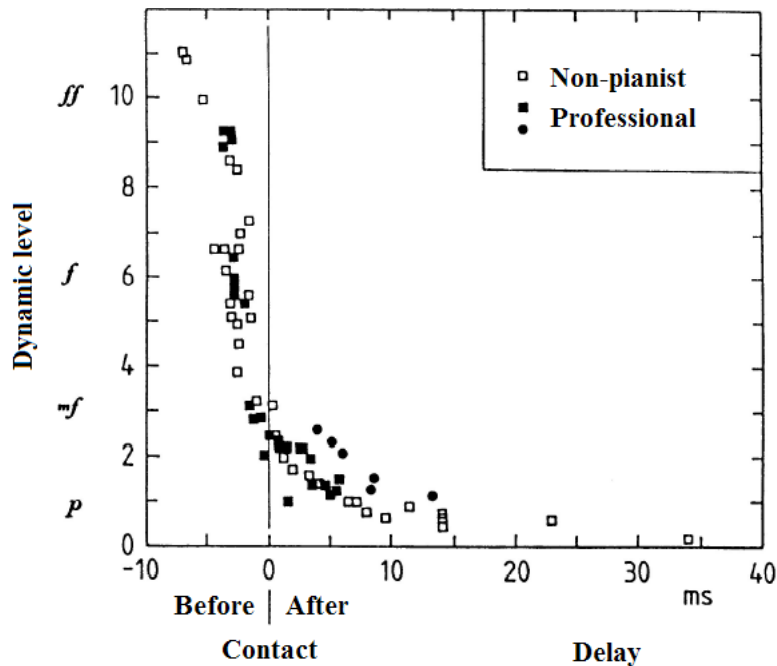

Figure 3.6: Relationship between dynamic level and key bottom delay (source: [5]).

Moreover, it was confirmed that even the physiological aspects of playing alter the evolution of the path and velocity of the action and, hence, the hammer. This last point can be verified in figure 3.8, which contains measurements of the hammer velocity for a key played with the same force but, in figure 3.8a, with finger movement only; in figure 3.8b, with arm and finger movement, with the finger relaxed; and in figure 3.8c, with arm and finger movement, with the finger rigid. In any of the three cases one can observe, however, that the hammer has the same velocity at the moment it reaches the string, which means that the sound produced will always be the same. The same happens in the previous case of articulation, just as explained in reference [5] (notice that, whereas figure 3.8 shows hammer velocity, figure 3.7 shows key velocity).

All the above results affirm that a solitary note played by a virtuoso effectively does not differ in quality from the same played by a novice. This affirmation is not valid for the vast majority of musical instruments, with which the artist produces the sound in a more direct way. Making a note sound pleasing could be an important achievement for a beginner violinist, for example.

Evidently, the enormous versatility and expressive capabilities of the piano have their origin in the way one combines several notes. One chord very well might sound like it was played by a concert performer, or by a novice. The difficulty in interpretation resides in knowing how to appropriately distribute the

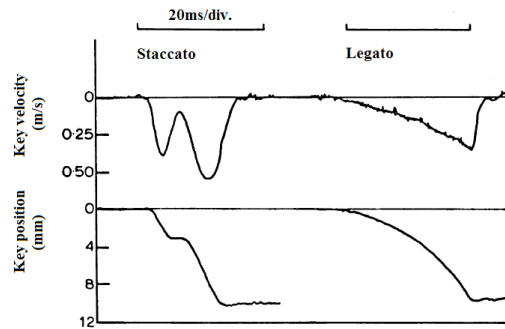

Figure 3.7: Influence of articulation in key movement (source: [5]).

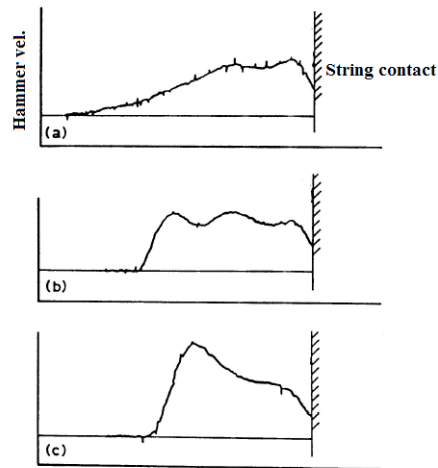

Figure 3.8: Influence of touch in hammer movement (source: [5]).

duration and relative dynamics of both simultaneous and successive notes. On the other hand, the foregoing discussion does not consider the effects of the dampers, whose apt handling, either by the way the keys are released or by the use of the right pedal, multiplies the interpretive possibilities and levels of expression, at the same time increasing the difficulty.

No other sources of noise have been mentioned up to this point. These include moving and stopping parts of the action, fingers striking the keys (called *key top noise*) and the bottom of the keys hitting the keybed (called *key bottom noise*). These noises contribute to the total sound effect, and should be considered within the tonal qualities of the piano. By far, the most important contribution is the key top noise. It is evident that this is directly controlled by the artist and completely depends on his articulation and how he plays the note. For example,

in *staccato* passages the noise is very present, and can even help accentuate the articulation, while in *legato* passages it is almost nonexistent.

Chapter 4

Hammer and string interaction

This physical aspect of the piano has been one of the most studied throughout this century, and is where the greatest advancements have been made in the last 15 or 20 years. The nonlinearity of the hammer-string system makes it one of the most intriguing and complex points to investigate. There is yet to be reached a real, definitive model that gives a complete solution to this physical problem. In this chapter, the results of a few studies are briefly shown, and an explanation is given of how certain characteristics of the interaction influence the final sound.

4.1 The nonlinearity of the hammer

In the first pianos, the hammers were covered with leather, usually deerskin. The leather would lose its elasticity very quickly, so it was replaced near 1830 by felt—a mix of cotton, silk and fur. Regulation of the hardness, texture and density of the felt, as well as the mass and size of the hammers, all parameters that vary across the register of the piano, is vital for a correct balance between the different notes, and is one of the tasks that require more care in manufacture. All of these influence the sound to some degree, as will be shown. Figure 3.5 showed that the contact time between the hammer and string lasts approximately 2 milliseconds. During this time, the force that one exerts on the other is not constant, but is determined by the deformations that take place, as well as the string's reaction. In general, the contact time can be divided into a rise period, during which the predominant force is the hammer pushing against the string, and a fall period, during which the string, acting like a spring, reacts and pushes back on the hammer, making it bounce back. As another explanation, during the rise, the hammer transfers kinetic energy to the string, and the inverse happens during the fall. During the rise the felt compresses, and during the fall it expands.

Figure 4.2 shows the deformation of the hammer in millimeters as a function of impact pressure for the hammers corresponding to notes 1, 37 and 73 (A0, A3 and A6). For each hammer, three levels of hardness were tested. Note that in

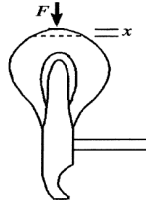

Figure 4.1: Measurement of hammer nonlinearity (source: [7]).

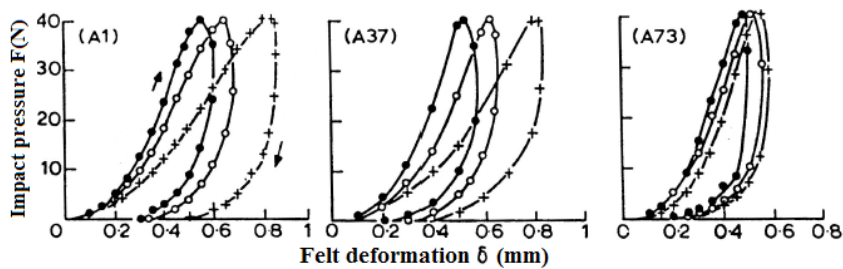

Figure 4.2: Felt deformation as a function of impact pressure (source: [8]).

the bass notes, the hammer deformation is greater, bordering on one millimeter. The graphs show the nonlinearity mentioned above: if the felt behaved linearly, which would make theoretical study much easier, the relationship between the force F applied to the felt and its deformation δ would be $F = k\delta$, and the graphs would be straight lines. The graphs also show what is called a *hysteresis cycle*: the deformation at a given pressure during the rise does not coincide with the deformation at the same pressure during the fall. This is because the expansion velocity of the felt during the fall is less than the hammer velocity. This, in turn, implies that after contact ceases the felt remains compressed for a few milliseconds. The hysteresis adds a new complication to the analysis of the system.

4.2 Contact time

The force acting on the string during the contact time was measured using sophisticated sensors [8]. The results are displayed in figure 4.3. For each note, the solid line represents the force, and the dotted line represents the felt deformation. In the plot corresponding to A1, one observes an interesting fact: for about one millisecond, there is no force exerted on the string, or in other words, there is a

momentary loss of contact. In this time, the felt can expand freely, indicated by the dashed line in the deformation graph. The momentary loss of contact is a consequence of the first wave reflections just created in the string by the hammer and returning to the contact point before the hammer has receded. As of yet no one knows exactly how much the loss of contact affects the sound.

Figure 3.5 showed that the contact time is less when the key is played with a greater force. On the other hand, figure 4.3 indicates that the contact time

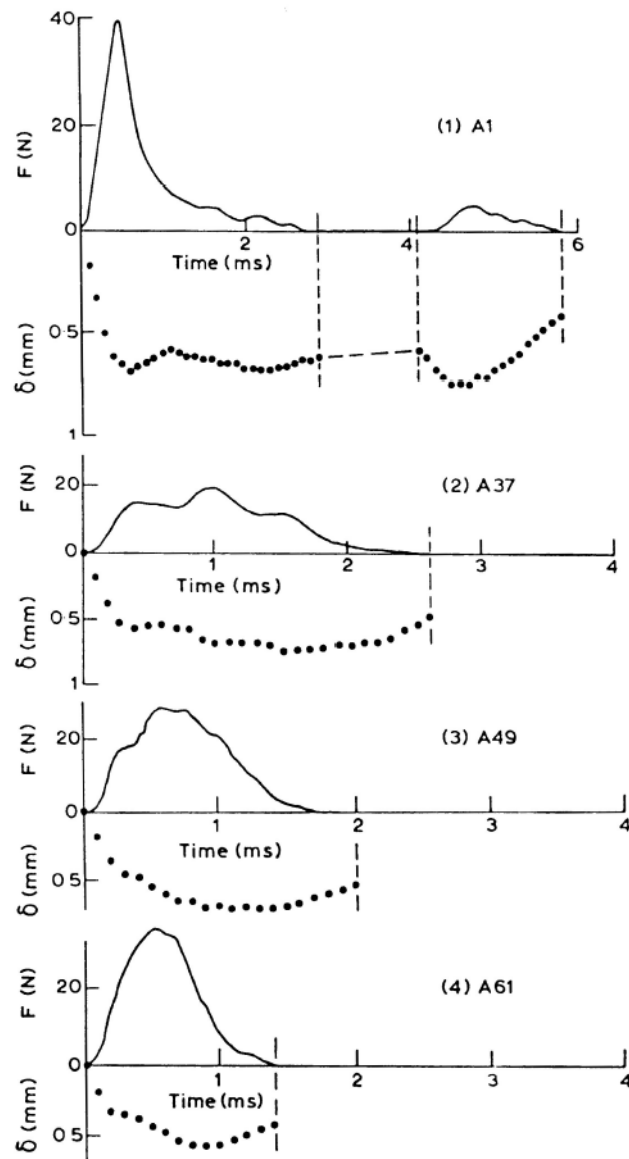

Figure 4.3: Deformation and force during contact time (source: [4]).

will also be less for a higher note, having a smaller hammer mass. The contact times for every note are given in figure 4.4, for a small vertical piano, a large vertical piano and a medium-sized grand. Each note was played with the same force. The discontinuities and irregularities in the curves are again due to the complicated wave reflections in the strings. Generally, for all pianos the contact time is approximately one half the vibration period of the string for the note C4. The frequency of C4 is about 262 Hz, with its inverse being the period, 0.0038 s. This yields a half-period of 0.0019 s, or about 2 milliseconds, which is the contact time. As can be verified, the above figure agrees with this: for C4 (note 40), the contact times of the three kinds of pianos are very close to 2 milliseconds. But in order to observe the contact time's consequences on the tone, another factor must be considered: the strike point. In the following discussion, it is assumed that a piano string's vibration modes are harmonic, although, as explained in the next chapter, they are in reality slightly inharmonic.

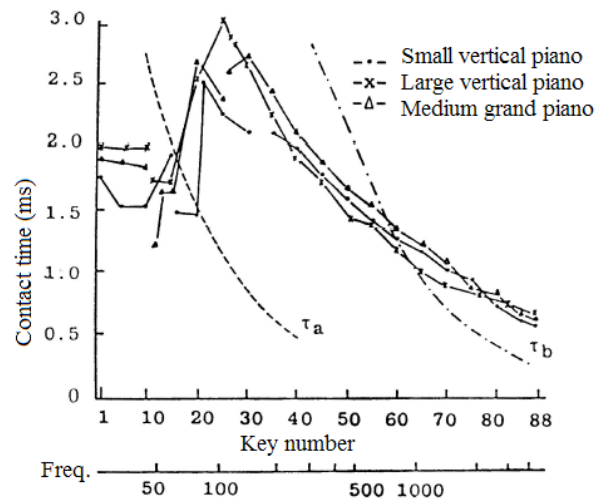

Figure 4.4: Contact times for entire piano register (source: [4]).

After many tests throughout the history of the piano, it was determined that the best strike point is between $1/7$ and $1/8$ the length of the string. In general, it can be verified that if the point where a string is *plucked* (not struck) coincides with a node of any one of the vibration modes, that mode will not be excited. The most intuitive case is the fundamental of a string fixed at both ends. Its nodes are at the ends, which means that the greatest excitation of the fundamental will happen if the string is plucked exactly in its center, that is, at the antinode of the first mode. As the string is plucked further from the center, it vibrates less, and it is impossible to excite it by plucking right at an end. Likewise, if a string is plucked at $1/7$ the length, the 7th mode is not excited, along with its multiple integers: 14th, 21st,.... In music, this phenomenon can be an advantage, since

the 7th harmonic is dissonant to the tempered minor 7th. This fact has been utilized as a justification for the choice of strike point in the piano, and it is still affirmed in some relatively recent articles and books [9, 10, 11].

However, studies have demonstrated that this argument is not completely valid. In the piano, the string is not plucked but struck, meaning one cannot assume that the interaction that begins the vibration is instantaneous. The hammer-string contact time is brief but long enough to form harmonic standing waves in the shorter section of the string (see figure 4.5). Assuming that the strike point is exactly $1/7$ the length of the string, the standing waves constitute the harmonic series of a frequency seven times greater than the entire string, which are precisely the supposedly eliminated harmonics (7, 14, 21...). As the hammer loses contact, all these are propagated across the rest of the string, and the final result is that all vibration modes are present in the string.

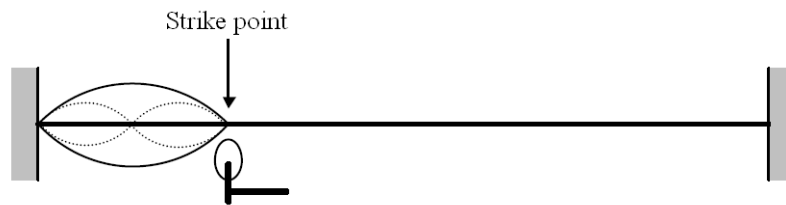

Figure 4.5: Standing waves formed during contact time.

It is at this point where contact time plays an important role: the longer the contact time, the smaller the amplitudes of the harmonic multiples of the 7th mode, since the standing waves in the short section of the string will have lost more energy before propagating. This is how the contact time affects the tone. The hammer mass also has an (indirect) influence, since a greater mass will equal a greater contact time.

4.3 Other factors to consider

Another important parameter to consider is the length of the hammer surface that is in contact with the string. If it is greater than the wavelength of a particular mode, this mode will be greatly attenuated. This phenomenon only affects the high-frequency partials, or those with a small wavelength. Therefore, the small, fine hammers of the treble section produce a more rich sound in the higher partials than do the bass hammers.

Similarly, harder hammers excite the higher modes more than softer ones. The felt compression during contact makes the hammer momentarily harder. Consequently, the greater the velocity of the hammer, the more it is compressed and the greater the higher partials are excited. This is why *fortissimo* notes are much richer than *pianissimo* in the upper part of the spectrum, as is seen in figure 4.6.

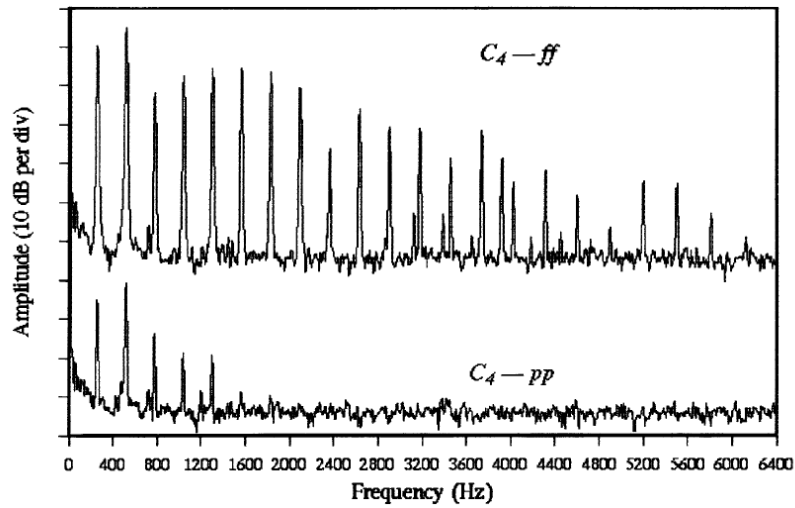

Figure 4.6: Spectra of C4 played *ff* and *pp* (source: [7]).

Chapter 5

The strings

5.1 Scale design

From a structural point of view, the piano can be compared to a zither with a keyboard action. It is also often referred to as a harp with keyboard, but this comparison is less adequate, since, whereas in the harp the strings are attached to a bar (the *neck*) and the sound box, entering it in an oblique direction, in the piano they are stretched parallel over the resonating body, as is the case with the zither. Unlike the zither, however, the piano's resonating body is not a box but a *soundboard*. The string vibrations are transmitted to it through the bridge, situated near the far end of the piano. Figure 5.1 provides the schematic of the string configuration. The speaking length of the string, or the length that determines its frequency, is measured between the *Capo d'astro* and the bridge. The string extends beyond these points to the tuning pin and the hitch pin, firmly anchored in the plate.

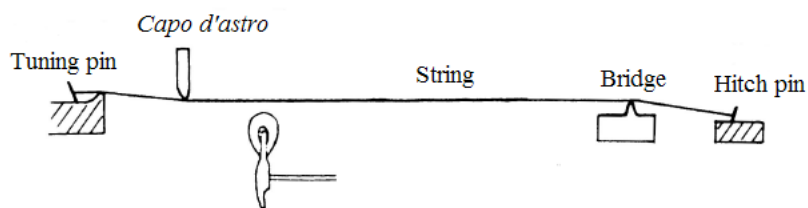

Figure 5.1: Schematic of the strings (source: [3]).

In the modern piano, the strings are made of steel. In the constant search for greater acoustic power, this material has made it possible to have greater tension, and therefore greater volume. The overall string tension of a grand piano can be up to 30 tons, and in a vertical, 14 tons. The double and triple-string notes also

increase the volume; however, they also have an unexpected effect on the tone, as will be seen. In general, the single and double-string notes, which constitute the bass, are copper-wound. The lower bass strings have increasingly thicker windings, and even double windings in the lowest notes. Another important characteristic in scale design is the *crossover section*, which consists of the area where the lower bass strings cross over the midsection strings, a consequence of the bass being on an independent bridge from the middle and treble. All mentioned scale design characteristics are shown in figure 5.2, each of which is addressed in this section and the next.

5.2 The string ratio

It is useful here to recall the formula that gives the frequency of a string fixed at both ends, as a function of tension, mass and length:

$$f = \frac{1}{2l} \sqrt{\frac{T}{\lambda}} \quad (5.1)$$

where l is the string length, T the tension and λ the linear density (mass per unit length). From this formula it is deduced that, for a string with the same tension and the same density (same material) to vibrate at half the frequency, or one octave below, its length must be doubled. No string instrument has the same tension and density across the entire register—they vary such that the length need not be doubled for each octave. In the violin or the guitar, for example, every string is the same length, and their different pitches are determined by their various densities (greater thickness leads to greater linear density) and tension. In the harp or piano, the strings do gradually increase in length, but not by a factor of two, which, in the case of the piano, would make the lower bass strings almost five meters long. The *string ratio* is the ratio of the string lengths of each successive octave. This ratio in turn depends on the density and tension ratio between adjacent octaves.

If f_2 is the frequency of a note one octave higher than a note with frequency f_1 , then, using eq. 5.1:

$$\frac{f_2}{f_1} = 2 = \frac{l_1}{l_2} \sqrt{\frac{T_2 \lambda_1}{T_1 \lambda_2}} \quad (5.2)$$

On the other hand, the linear density is equal to the specific density of the material (density per unit volume) times the cross-sectional area of the string, assumed to be perfectly circular. That is,

$$\lambda = \rho \pi r^2 = \frac{\rho \pi}{4} d^2 \quad (5.3)$$

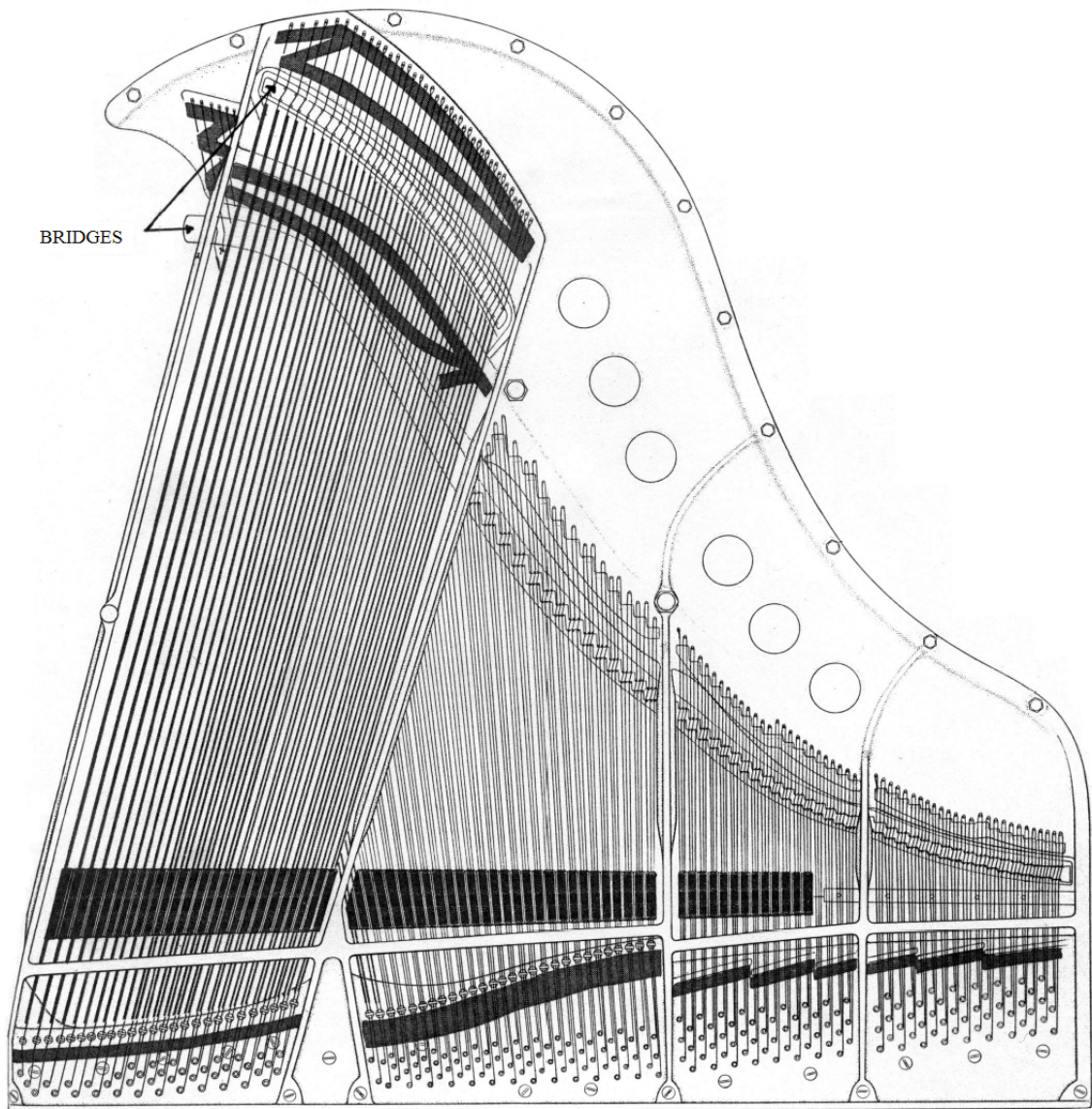

Figure 5.2: Typical piano scale design (source: [2]).

where ρ is the specific density and $d = 2r$ is the diameter of the string. Substituting in eq. 5.2, and assuming that both strings are made of the same material ($\rho_1 = \rho_2$), yields:

$$2 = \frac{l_1}{l_2} \sqrt{\frac{T_2}{T_1} \frac{d_1}{d_2}} \quad (5.4)$$

where $\frac{l_1}{l_2}$ is the string ratio (SR), $\frac{T_1}{T_2}$ the tension ratio (TR) and $\frac{d_1}{d_2}$ the diameter ratio (DR), which is proportional to the square root of the density ratio, as derived from eq. 5.3. Solving for SR :

$$SR = 2 \frac{\sqrt{TR}}{DR} \quad (5.5)$$

$$l_1 = SR l_2 \quad (5.6)$$

For the piano, $TR \approx 1.2$ and $DR \approx 1.15$, so that $SR \approx 1.9$. Keep in mind that the optimal length for C4 is between 60 and 65 cm. With all this, the following relationship between octave frequencies and string lengths in meters is obtained:

$$l = SR^{4-oct} l_{C_4} \quad (5.7)$$

where oct is the octave number and l_{C_4} is the length of C4. Applying this equation yields the result of about four and a half meters as the length for C1, as indicated in figure 5.3. In order to avoid these impractical lengths, the string ratio is gradually reduced in the bass area, which gives the piano its winged shape. Eq.

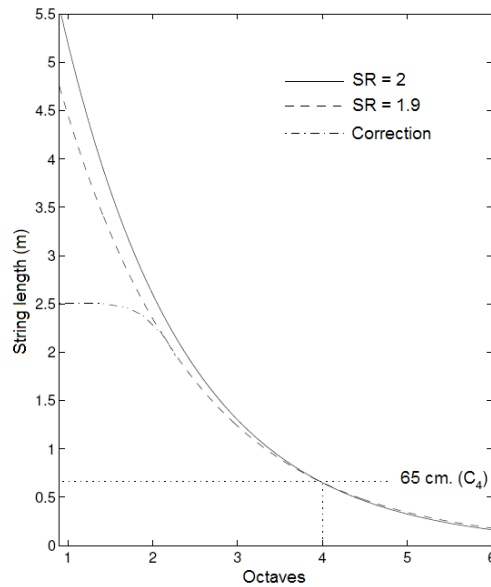

Figure 5.3: Comparison of different string ratios

5.5 suggests that this can be obtained by gradually increasing DR , or increasing the diameter for lower frequencies. This is done by winding the string in copper. The amount that SR is modified depends on the type and size of piano. In a concert grand, for example, the lowest string is no longer than two meters.

5.3 Inharmonicity

In most chordophones, the strings' partials are harmonic, as is the case for an ideal string, or one with infinite elasticity, fixed at both ends. In reality, all strings possess some stiffness, but in most cases the deviation from the ideal case is negligible. In the piano, the enormous tension to which the strings are subject makes them extremely rigid, and a non-ideal perspective for the problem is necessary.

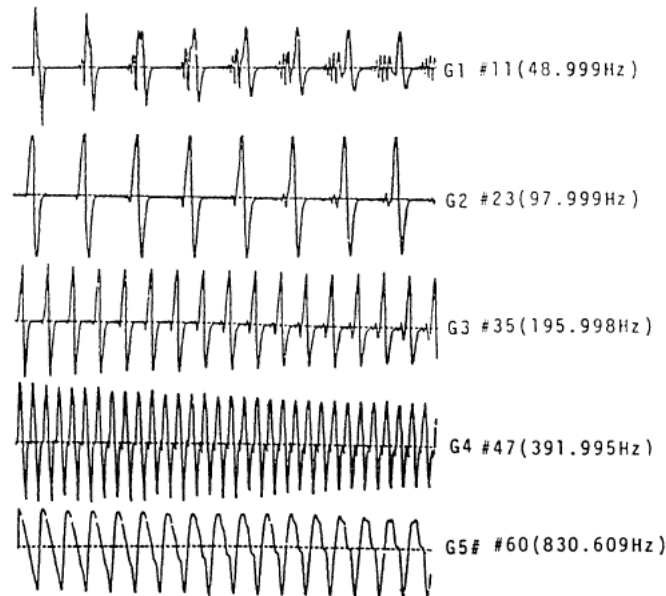

Figure 5.4: Waveforms for various G notes (source: [4]).

It was experimentally proven that stiffness affects the string by acting as a dispersive medium. This means that the sound waves propagate at different velocities that are dependent on frequency. A higher frequency causes faster propagation. Therefore, in the case of a complex musical sound, the higher partials propagate faster than the fundamental and lower partials. This can be seen in figure 5.4, where the waveforms have been calculated for 5 notes, taking into account the stiffness. In the waveform for G1, there is initially only one wave crest which contains all the partials, but then a group of small crests,

corresponding to the higher partials, begin to form ahead of the main crest after some time has passed. The same phenomenon occurs for all other notes, though it is not as apparent. It can be demonstrated mathematically that this effect results in *inharmonic*ity of the partials: the modes are no longer exact integer multiples of the fundamental. In the case of the piano, the inharmonicity causes the partials to deviate towards higher frequencies (figure 5.5). On average, the inharmonicity causes the 10th partial to be one third of a half step sharp, and the 20th partial to be one whole step sharp. The 15th partial coincides approximately with the theoretical frequency, were there no stiffness, of the 16th partial.

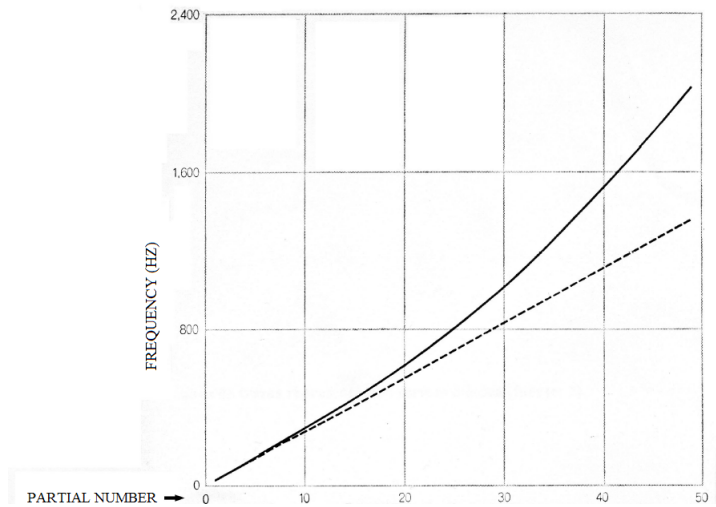

Figure 5.5: Inharmonicity. The dashed line is a harmonic series (source: [2]).

The frequency of the n th partial for a rigid string is given in the following formula:

$$f_n = f_0 n \sqrt{1 + Bn^2} \quad (5.8)$$

where f_0 is the fundamental frequency, n is the partial number and B is the *inharmonic*ity coefficient [12]. This coefficient represents the degree of inharmonicity, and is directly proportional to the tension applied and to the diameter/length ratio of the string. The inharmonicity will therefore vary throughout the piano register. This variation is shown in figure 5.6. It can be observed that the inharmonicity is minimal in the midsection and increases further into the bass and treble. There are two reasons for the increase in the bass: first, the strings have a greater diameter/length ratio, since the string ratio is successively decreased and the diameter successively increased, which increases B . Following the same reasoning, grand pianos have less inharmonicity in the bass than do

verticals because of the longer bass strings. Second, the copper winding causes additional reflections of the wave where it ends, near the *Capo d'astro* and the bridge. It has been verified that these reflections contribute to the inharmonicity. Likewise, B increases in the treble because the short length and high tension cause the strings to act more like bars.

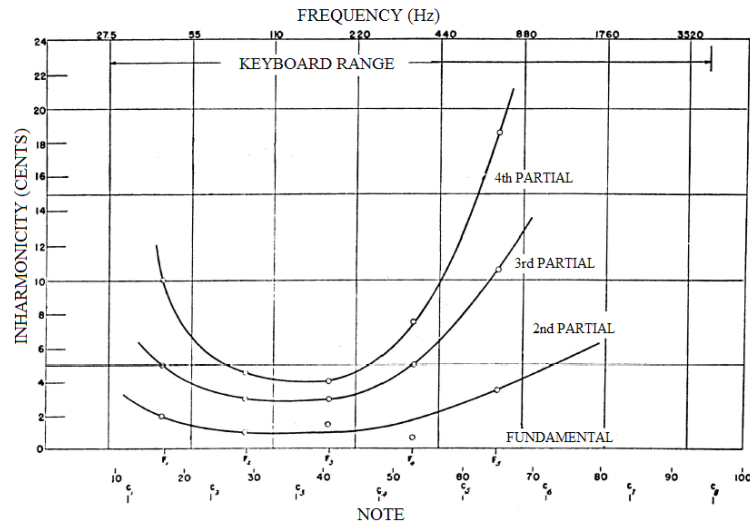

Figure 5.6: Inharmonicity across the piano scale (source: [13]).

Is inharmonicity a desirable effect? In the first half of the century many methods were proposed to compensate for it. However, a series of experiments and surveys done in 1965 at Brigham Young University demonstrated that slight inharmonicity was not only desirable, but also one of the characteristics that most added richness and quality to the sound of the piano [2]. Using a series of electronic oscillators, two piano sounds were synthesized: one with perfectly harmonic partials and the other with some deviation. The samples were submitted to a jury made up of musicians and non-musicians. Both kinds of judges described the harmonic sound as “cold.” The subjective evaluation of the sound of piano chords (several notes played together) as “hot” perhaps is related to the beats produced in sharper partials, due to the inharmonicity. The jury was also able to distinguish between synthetic harmonic sounds and real piano sounds, but they were only able to distinguish half the time between synthetic inharmonic sounds and real sounds.

Nonetheless, excessive inharmonicity does indeed lower the sound quality. In figure 5.6, it is seen that the inharmonicity increases notably in the lower and higher frequencies. This is less of an issue in the higher frequencies, since their higher partials are in the range of inaudible frequencies. In the bass, however, all the relevant partials are audible. In the spectrum of the piano’s bass notes, the

fundamental has a much lower amplitude than the first few harmonics. The ear, lacking a clear fundamental, attempts to “reconstruct” the sound’s pitch based on the differences between successive partials. If these are perfectly harmonic, the fundamental is easily found and the hearer “imagines” hearing the complete sound. If the partials are very inharmonic, the pitch is confusing, and the sound is considered less pleasing. For this reason it is best to decrease the inharmonicity in the bass notes of the piano. This is achieved by making the strings as long as possible—one of the reasons why a grand piano, with longer bass strings, is considered higher quality than a vertical. In the midsection and treble, there is no substantial difference in inharmonicity between grands and verticals.

Lastly, it is appropriate to point out an interesting effect that inharmonicity has on piano tuning [13]. The tuning process consists of eliminating as much as possible the beats that are produced between certain partials when comparing a series of intervals. First, one of the middle octaves is tuned and, based on the components of its notes, the rest are tuned by “skipping around.” Given that these components are inharmonic, the result of the comparison is that the higher octaves are tuned further and further *above* the temperament, and the bass octaves are tuned further and further *below* (fig. 5.7). This method is known as *stretched tuning*. The overall deviation is some 30 cents between C1 and C8, since C1 is 15 cents lower than the temperament and C8 is 15 cents above. Not even the octave, which is the only theoretically correct interval of a tempered tuning, is exact in the case of the piano. However, the stretched tuning is necessary so that the piano is in tune with *itself*.

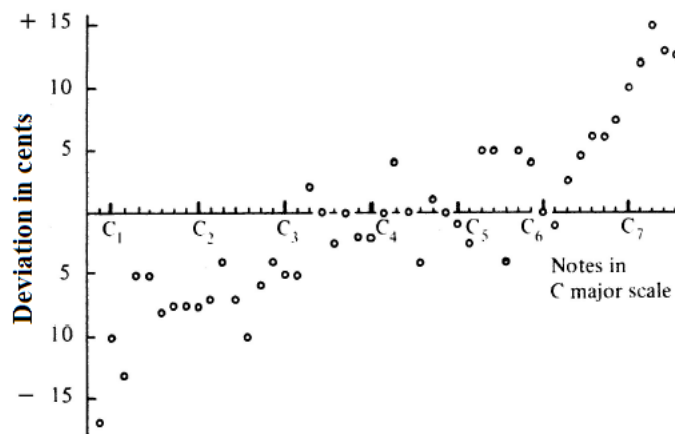

Figure 5.7: Stretched tuning (source: [3]).

5.4 Double decay

The sound of a piano is made by free vibrations. This means that, once energy has been transferred to the string through the hammer, it vibrates freely, in contrast to the violin, for example, where the force is maintained by the bow. Therefore, the temporal evolution of the sound's amplitude, or the envelope, is not maintained at any point, but is instead determined by the way the string loses this energy. Remember that the time envelope plays just as important a role as the spectrum in the characterization of the sound of an instrument. It is therefore of greatest interest to study the time decay of the notes. Throughout the following discussion the dampers will not be considered, since, in discussing time decay, it is understood that the note is held until the sound is inaudible.

Time decay was first studied with some experimental rigor in the 40's [14]. By measuring the envelopes, graphs like figure 5.8 were obtained, for most notes. In the figure, one can see that the attack phase is almost instantaneous, as would be predicted for a percussion instrument. As expected, there is no phase where the amplitude is maintained. The interesting results are seen in the decay: there is a first phase during which the decay rate is high, and a second during which the sound decays more slowly. The first phase of the decay is known as the *immediate sound*, and the second as the *resonance*. This phenomenon, known as *double decay*, is an acoustical characteristic that is almost exclusive to the piano, and it has intrigued scientists ever since. It was not until 1977 when a satisfactory explanation was provided, in the publication of Gabriel Weinreich's important article "*Coupled piano strings*," in the Journal of the Acoustical Society of America [15]. This article constitutes one of the milestones in the study of the piano.

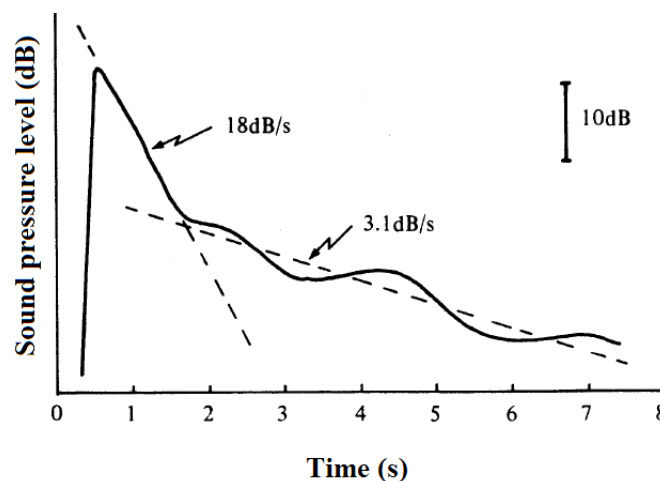

Figure 5.8: Double decay (source: [3]).

Weinreich came to the conclusion that the double decay originates principally in the use of double and triple strings. As mentioned in the introduction, this is a strategy used since the beginnings of the clavichord, with the objective of increasing the volume. Another way of doing this could have been to use single strings with a larger diameter, but in the case of the piano this would have created too much inharmonicity.

It is practically impossible to tune a group of unisons perfectly with each other, and in practice they are usually off by a few cents. As with inharmonicity, from a physicist's point of view, these small inaccuracies could be undesirable, but the musical standpoint has once again proven otherwise. First, the resonance phase greatly contributes to the piano's ability to sustain notes for a prolonged period of time, one of its greater attractions. Second, the beats produced by the off-tuning enrich the sound similar to the way the inharmonicity did. Other surveys were done, in which the majority concluded that a perfectly tuned piano sounded *dead*. These days, good tuners slightly detune the unisons according to careful calculations.

Simply using multiple strings, even if they are perfectly in tune, already introduces the double decay. The off-tuning also contributes, independently. The following discussion explains both cases separately.

For the first case, suppose that the strings are perfectly in tune. To simplify, consider only two strings. These pass over the bridge very close to each other. It is then said that they are *coupled* through the bridge: there is a large mutual transmission of vibrations, or in other words, the movement of one greatly influences the movement of the other. The energy transfer through air is negligible in comparison. The amount of energy transferred depends on the phase difference of the string movements. The movement of the bridge is the sum of the two string movements. If the strings vibrate at the same frequency and amplitude, but with opposite phases, the bridge does not move and the energy transfer is cancelled. If the strings vibrate in phase, the bridge movement is twice that of a single string, and the energy transfer is at a maximum. The coupling between the strings and the bridge constitutes what is called a *resistive support*. This type of support does not change the string's frequency even though it does affect its movement. The bridge in turn couples the strings with the soundboard. The energy is transferred through the bridge to the soundboard, where the sound is then radiated in the air. As the energy transfer between strings and soundboard increases, string movement is dampened, and the sound is shorter and more intense. If the transfer is small, like when the two strings have opposite phase, the energy is slowly dissipated, prolonging the sound but with a low volume. How is it then explained that two unison strings that supposedly vibrate in phase after being struck by the hammer, and therefore transfer their energy to the bridge very quickly, can have exactly the opposite effect, that is, increase the decay time?

The reason is that in a real acoustical situation it is impossible for two strings

to vibrate in *exactly* the same phase. Random irregularities slightly alter the movement and break the symmetry. In the piano's case, the greatest source of irregularities is the contact surface of the hammer, which cannot be assumed to be perfectly smooth. For this reason, on impact one string has a slightly greater amplitude than the other (figure 5.9). At first, the two strings vibrate in phase and their movement superimpose at the bridge. The energy transfer to the soundboard (or equivalently, the attenuation) is quick. This is the *immediate sound* phase. When the string with smaller initial amplitude is completely attenuated, it does not stop moving; the bridge still vibrates because of the other string and forces the first to continue vibrating. In a resistive support, as in this case, there is always a phase difference of a fourth of a period between the string movement and bridge movement induced by it (the demonstration of this property is straightforward and is omitted here). Likewise, if a moving bridge pushes an initially stationary string, the phase difference is again a quarter period. In the present discussion, one string moves the bridge (the string that has not completely attenuated), and the bridge in turn moves the attenuated string. The phase difference between the two strings is therefore a half period, and they have opposite phase. From this point on, the bridge hardly moves and the decay takes much longer: this constitutes the *resonance* phase.

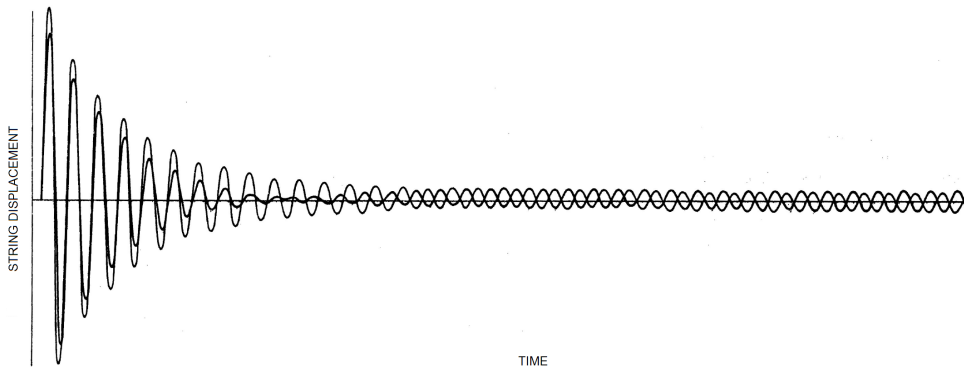

Figure 5.9: Vibrations of two coupled strings (source: [15]).

As mentioned, the off-tuning also contributes to the double decay. Here, the physical explanation is much more complicated. In simplest terms, the two strings vibrate in phase immediately after impact, producing the immediate sound. Because they are slightly out of tune, their frequencies are slightly different, and little by little they get out of phase. Once this phase offset becomes approximately a half period of one of the frequencies, the movement almost completely cancel at the bridge, and the sound is sustained.

It has been experimentally proven that the multiple-string notes are essentially

the predominant factor in the double decay phenomenon, but other contributing factors exist. One of the most important is the existence of two vibrational directions, or *polarizations*. The string not only moves vertically (in a grand) but, because of imperfections in the hammer surface, somewhat horizontally as well (see figure 5.10). Immediately after impact, the vertical component is more than ten times the horizontal component, but because of the way the strings are attached to the bridge, the vertical component is attenuated much quicker (the bridge responds mostly to vertical movement). Thus the horizontal component, weaker and with slower decay, is the only one remaining after some time, contributing to resonance. Note that in this case multiple strings are not considered, which is why it is possible to witness double decay in single strings, as the experiments demonstrate. There is still controversy among investigators of the piano concerning the influence of the polarizations in double decay. While some articles, like Weinreich's, say that it is substantial, others deny it even exists [16].

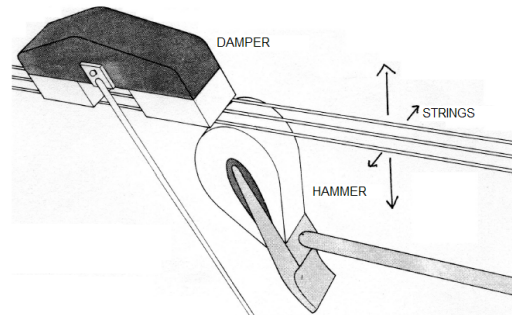

Figure 5.10: Vibrational components of a string (source: [15]).

Double decay is especially noticeable in the middle register. The two separate curves of the decay envelope are closer together for higher notes in the scale. In the highest notes, the decay is made up of just one continuous curve. Moreover, the decay is much faster for higher notes, since the air better absorbs the high frequencies. In the bass, the unisons takes longer to get out of phase, causing the immediate sound to dominate a good part of the decay (see figure 5.11). In some cases, there are oscillations in the decay, in part due to the off-tune beats and also the rotation of the polarization plane. Figure 5.12 shows an average of decay times for the entire piano. The x-line shows the time (in seconds) that the sound would take to diminish by 60 dB if the decay curve were only made up of the immediate sound. The dotted line shows the decay time if it were only made up of resonance. In the treble, both lines converge, as corresponds to simple decay. The figure does not indicate the duration of each phase of the decay, only the curve difference between both: the more separated these lines are, the more abrupt the change in slope.

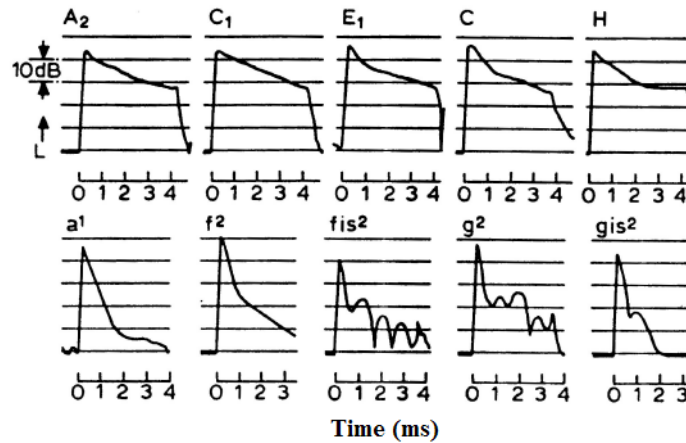

Figure 5.11: Average decay envelopes for certain notes (source: [4]).

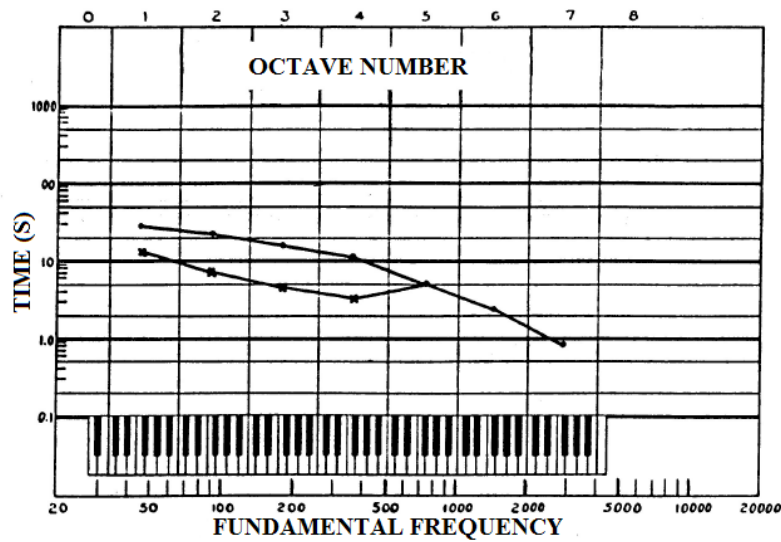

Figure 5.12: Double decay with respect to string position on a grand (source: [14]).

5.5 Spectral consequences

The observations made in the last paragraph about decay times for different frequencies is not only true for notes, but also the partials. The higher partials decay more rapidly because of the high absorption in the air at those frequencies. Likewise, the lower partials are heard almost exclusively during the immediate sound. This is the same as saying that the sound becomes inaudible before passing into the resonance phase. Although the sound is there, it is too quiet for the

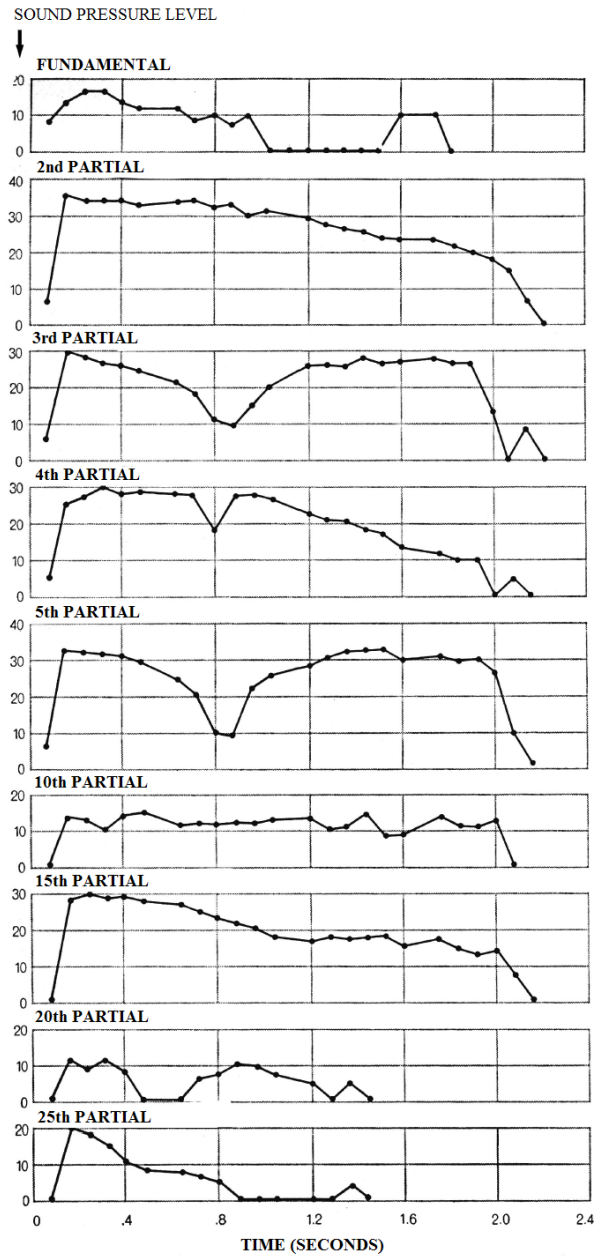

Figure 5.13: Decay curves of some partials of C1 (source: [2]).

human ear to detect (the hearing threshold for low frequencies is relatively high). Thus the lower partials disappear more quickly than the middle ones, which are present throughout most of the resonance phase. Moreover, the longer strings have the property of producing the first few partials at a lower amplitude than

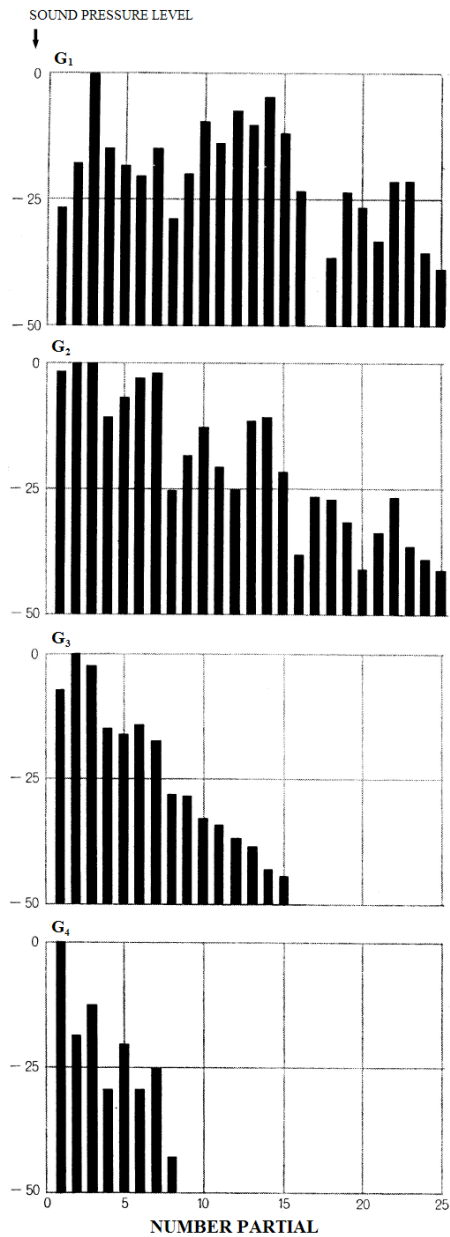

Figure 5.14: Maximum spectra of several notes (source: [2]).

the mid-partial, which amplifies the effect. These considerations are reflected in figure 5.13, where the decay envelopes for each partial for C1 appear. Note that some partials even increase in intensity before finally decaying.

The last statement that the lower partials decay faster does not mean that lowest notes take longer to dissipate. These have especially rich spectra, and the

sound is sustained by the large number of mid-partials present. Even if the first few partials have little to no presence during the majority of the sound, the ear uses mechanisms to correctly determine the pitch, as was mentioned in the section on inharmonicity. Despite this, it is possible at times to perceive a gradual pitch change (towards higher frequencies) during the decay.

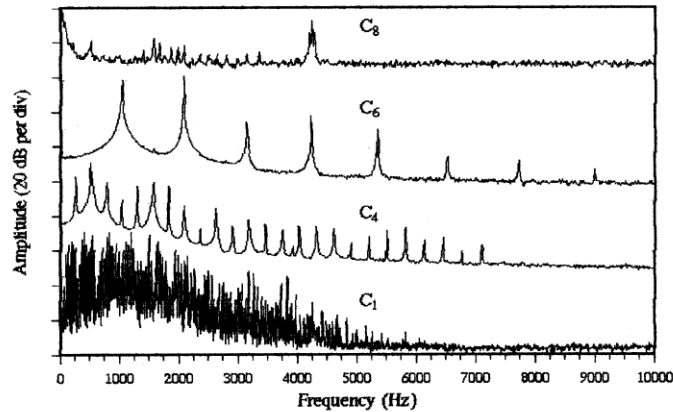

Figure 5.15: Averaged spectra of four different notes (source: [7]).

Consequently, the tonal quality of the piano is not constant—the *frequency spectrum* varies as a function of time. This is another of the particular characteristics of the sound of the piano. Figure 5.14 shows the *maximum spectra* of four different notes. Each bar represents the maximum amplitude that a partial reaches throughout the decay. In the first spectrum, the fundamental has a lower amplitude than the mid-partials. The treble notes have less partials that are relevant and/or audible because of the recently mentioned effect of air absorption. For each note, the high partials are more present as the note is played harder, as explained in the chapter on the hammer-string interaction. A similar way of representing a varying spectrum at once is by averaging the amplitudes. Figure 5.15 shows the real spectra of several notes, without simplifications.

5.6 The pedals

The right pedal, or sustain pedal, does not only have the obvious effect of controlling the sustain by moving the dampers, but also has tonal consequences. By allowing all the strings to vibrate freely, those that are more or less close to the partials of a played note will vibrate sympathetically, thus altering the complete sound. The sympathy is produced in part through the air and in part through the bridge. The treble strings, which do not require dampers due to their short decay time, are always exposed to the sympathetic vibrations caused by the other notes, but the effect is almost negligible. On the other hand, when playing these notes while the dampers are lifted, the sympathetic vibrations of the partials of the longer strings are rather strong and very noticeable.

Many modern composers have taken advantage of the phenomenon of sympathetic vibrations as a creative resource. The example in figure 5.16, from volume IV of “Mikrokosmos” by Béla Bartók, is one of the most well known. The diamond shaped notes mean that the keys should be played soft enough to not produce any sound, so that their dampers are lifted. The strong opening chord in the right hand induces vibrations in the other three notes, which make up the accompaniment to the melody.



Figure 5.16: Example of utilizing sympathetic vibrations (excerpt from “Mikrokosmos” by Bartók).

The left pedal of a grand piano, the *una corda*, shifts the action such that the hammers only strike two of the three strings in the triple-strung section. The name *una corda* comes from the period when pianos were made with double strings. This does not have the commonly believed effect of decreasing the total acoustic power. Suppose there are two strings paired together. If one is struck, the other will begin to vibrate in opposite phase because of the transfer across the bridge, in a very similar way to that explained in the section on the double decay (figure 5.17). The power of the immediate sound is effectively reduced, since only the first string contributes to it. However, as seen in the figure, the sound level during resonance is appreciably increased with respect to normal playing (see figure 5.9). The real effect of this pedal, then, is an increase in the ratio of resonance sound to immediate sound, which produces a smoother sound better

suited for *cantabile* passages. In vertical pianos, a similar effect is achieved by bringing the hammers closer to the strings.

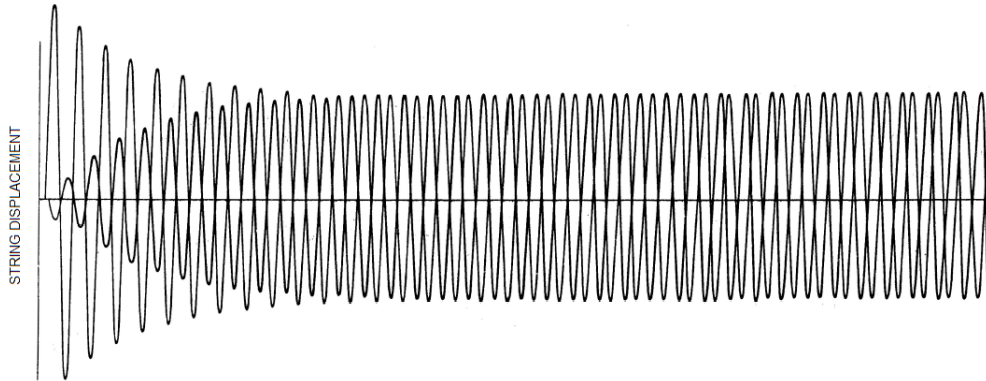

Figure 5.17: Vibration of two strings with the *una corda* engaged (source: [15]).

Chapter 6

The soundboard

As with any acoustic instrument, the purpose of the resonating body is to amplify the sound and appropriately radiate it. After many tests throughout the technological evolution of the piano, the conclusion was that an instrument of this kind had best results with a soundboard, instead of a sound box. The piano case, that is, the structure that surrounds the keyboard, plate and soundboard, is often incorrectly called the sound box, when in reality it never serves as a sound amplifier.

The soundboard is currently made of laminated spruce, with ribs made of the same material running across it perpendicular to the grain, in order to equalize the stiffness of the board in both directions. The board is approximately 1 cm thick.

The wide register of the piano requires a soundboard capable of uniformly amplifying a wide range of frequencies. Industrial advancements have made it possible to construct boards with a relatively flat frequency response. In order to achieve this, each vibrational mode of the board must be able to respond to a large scope of frequencies. The frequency responses of the modes superimpose and form the total frequency response of the board, which becomes flatter as the modal frequency responses are broadened. In general, the closer a string is to the center of the soundboard, the better it is amplified. This is one reason for scaling the strings on two levels (*crossover*). By separating the lower bridge and placing it in a more central area, the bass amplification is noticeably improved. See figure 5.2 for the bridge positions. Figure 6.1 displays the soundboard's vibrational modes for a vertical piano, experimentally measured. Figure 6.2 displays the modes for a grand, created using computer simulation.

The strings, because of their high tension and stiffness, create much pressure over the bridge, pushing it down (figure 6.3). The total force that the soundboard has to withstand, which depends on the angle the string makes at the hitch pin (labeled as α in the figure), is enormous, and in order to hold it better, the board is somewhat convex instead of flat. With time, this pressure reduces the convexity, which deteriorates the elasticity and resonating characteristics of the

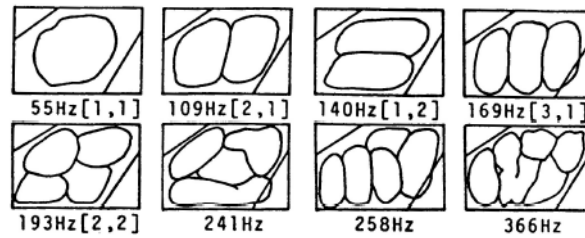

Figure 6.1: Vibration modes of the soundboard in a vertical piano (source: [4]).

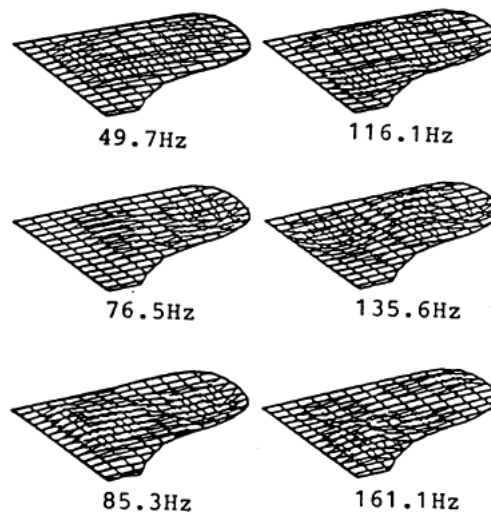

Figure 6.2: Vibration modes of the soundboard in a grand (source: [4]).

board. For this reason it can be verified that the piano is an instrument whose sound deteriorates after many years, unlike violins, for example, whose sound quality improves over time.

The *acoustic impedance* is a physical magnitude that measures the resistance of a body against sound waves. In general, for two bodies in contact, the energy of a wave is transmitted better as the two impedances are closer to each other. In the piano, the soundboard, bridge and ribs are considered to be the same vibrating body, whose impedance is sufficiently high in comparison to the strings. The difference of impedances is established in piano construction so that there is an acceptable balance between sustain and acoustic power. In order to lengthen a poor sustain, the treble section of the board is gradually made thicker, and the distance between the bridge and the hitch pin is shortened, increasing impedance in that area. The copper-wound strings have a considerably higher impedance

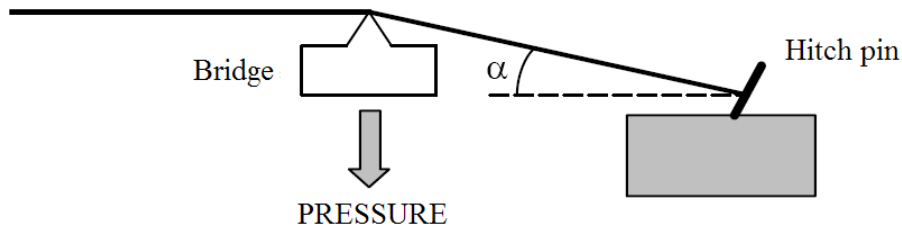

Figure 6.3: String pressure

than the plain strings, which could cause a sudden change of sound quality across the register. The solution to this problem is again found in the crossover section—note that it is precisely the wound strings that sit above the rest. The lower bridge is designed to compensate for this change in impedance.

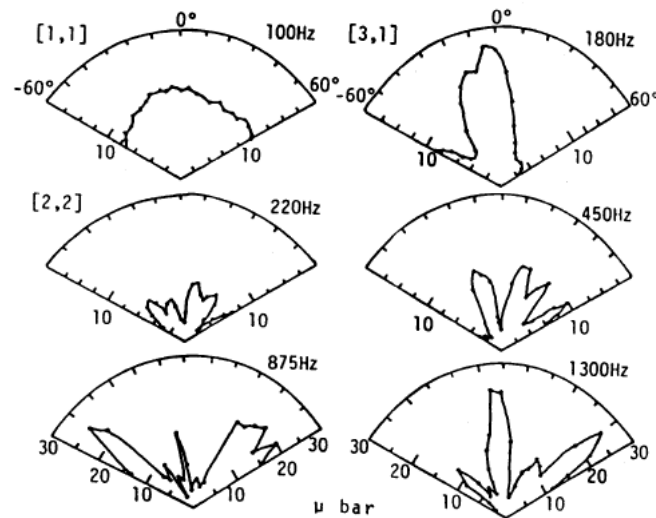

Figure 6.4: Directivity plots in the horizontal plane of a vertical piano (source: [4]).

The directivity plots in the horizontal plane for a vertical piano appear in figure 6.4. The directivity is uniform for frequencies below 100 Hz ($\approx A2$), but has a clear directivity for higher frequencies. Figure 6.5 shows vertical directivity plots of a grand piano with the lid open (thick lines) and closed (thin lines). It is interesting to see that for 250 Hz, the acoustic pressure is greater behind

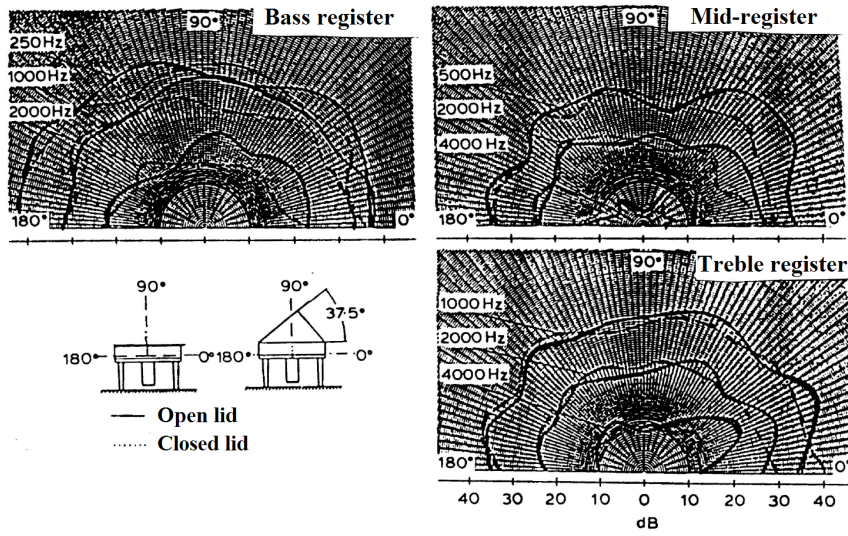

Figure 6.5: Directivity plots in the vertical plane of a grand (source: [4]).

the piano than in front. The effect of the open lid is more noticeable at high frequencies.

Bibliography

- [1] S. Birkett. Technical foundations for analysis of pianos, a research proposal. *Available online at: www.uk-piano.org/piano_research*, 1999.
- [2] E.D. Blackham. The physics of the piano. *Scientific american*, 213 (6), 1965.
- [3] M. Campbell and C. Greated. *The Musicians' guide to acoustics*. Dent & Sons, 1987.
- [4] H. Suzuki and I. Nakamura. Acoustics of pianos. *Applied Acoustics*, 30, 1990.
- [5] A. Askenfelt and E. Jansson. From touch to string vibrations: an experimental study of the initial course of the piano tone. *Journal of the Acoustical Society of America*, 61, suppl. 1, 1987.
- [6] P.R. Dijksterhuis. De piano. *Nederlandse Akoest. Genootschap*, 7, 1965.
- [7] D.A. Russell. Hammer nonlinearity, dynamics and the piano sound. *Available online at: www.gmi.edu/drussell*, 1997.
- [8] T. Yanagisawa and K. Nakamura. Dynamic compression characteristics of piano hammer felt. *Journal of the Acoustical Society of Japan*, 40 (11), 1984.
- [9] H.F. Olson. *Music, Physics and Engineering*. Dover, 1967.
- [10] C.A. Culver. *Musical acoustics*. McGraw-Hill, 1956.
- [11] E. Good. *Giraffes, black dragons and other pianos*. Stanford University Press, 1982.
- [12] A. Galembo. Personal web page dedicated to piano acoustics. *Available online at: www.geocities.com/CapeCanaveral/Lab/8779*.
- [13] O.H. Schuck and R.W. Young. Observations on the vibrations of piano strings. *Journal of the Acoustical Society of America*, 15 (1), 1943.
- [14] D. W. Martin. Decay rates of piano tones. *Journal of the Acoustical Society of America*, 19(4), 1947.

- [15] G. Weinreich. Coupled piano strings. *Journal of the Acoustical Society of America*, 62(6), 1977.
- [16] T.C. Hundley, H. Benioff, and D.W. Martin. Factors contributing to the multiple rate of piano tone. *Journal of the Acoustical Society of America*, 62(6), 1978.